

EN-106

HOME DIGITAL MODULATOR



SAFETY NOTES

Read the user's manual before using the equipment, mainly " SAFETY RULES " paragraph.

The symbol  on the equipment means "SEE USER'S MANUAL". In this manual may also appear as a Caution or Warning symbol.

WARNING AND CAUTION statements may appear in this manual to avoid injury hazard or damage to this product or other property.



T A B L E O F C O N T E N T

1	GENERAL.....	1
1.1	Description.....	1
1.2	Specifications	2
2	SAFETY RULES	5
2.1	General.....	5
2.2	Maintenance.....	6
2.2.1	Cleaning Recommendations	6
3	INSTALLATION	7
3.1	Power Supply.....	7
3.1.1	Operation via external power supply	7
3.2	Connection	7
3.2.1	Connection diagram examples.....	7
3.3	Navigation and edition of values.....	8
4	OPERATING INSTRUCTIONS.....	9
4.1	Description of controls and components	9
4.2	Starting	10
4.3	BASIC configuration menu.....	10
4.4	ADVANCED configuration menu.....	11
4.5	Menu tree	14
4.6	Parameter only accessible from the Configuration Utility	15
5	CONFIGURATION UTILITY.....	16
5.1	Installing the EN-106 Configuration Utility.....	16
5.2	EN-106 Configuration Utility	16
5.2.1	Configuration	17
5.2.2	Updating.....	18
5.2.3	Help	19
ANNEX 1	REFERENCE TABLE FREQUENCY – CHANNEL FOR UHF	20
ANNEX 2	RECOMENDED VALUES TABLE	22
ANNEX 3	TROUBLESHOOTING.....	24





HOME DIGITAL MODULATOR EN-106

1 GENERAL

1.1 Description

The **EN-106** is a module able to generate a signal in **DVB-T** format (Digital Terrestrial Television) from an audio / video (A/V) analogue input.

The audio / video analogue input has three **RCA** sockets, one for **VIDEO** signal and two more for **RIGHT** and **LEFT** audio signal.

These two analogue signals are processed through a MPEG-2 compression system, that digitises and compresses them, obtaining then a MPEG-2 transport stream, which is digitally modulated in order to obtain a multiplex, with a television service, at the DVB-T output socket.

This **DVB-T** signal can be inserted via the RF input (for loop-through) into an already existing television distribution network, with the advantages of robustness and high quality that digital technology offers.

The **EN-106** module adjusts the compression rate to the available bandwidth, using the modulation **DVB-T** parameters.



1.2 Specifications

INPUTS

Input Channels	1
Video	Composite (CVBS).
Video System	PAL / NTSC / SECAM.
Audio	0,5 – 2 Vpp.
Impedance	10 kΩ.
Bandwidth	20 Hz to 20 kHz.
Audio system	2 x Mono / Stereo.

COMPRESSION

Video	MPEG-2 MP@ML.
Video Resolution	720 x 576 25 fps (PAL).
Video Bitrate	According to DVB-T modulation parameters.
Audio	MPEG-1 Layer II
Audio Bitrate	From 96 to 384 Kbit/s (Selectable: Stereo, Mono, Dual, Joint Stereo).
DVB insertion tables	SDT, NIT, EIT.
Editable fields	Service Name, transport_stream_id, service_id, network_id, original_network_id, LCN, NIT, Private Data Specifier.

MODULATION

Standard	DVB-T (ETSI EN 300 744).
Constellation	QPSK, 16QAM, 64QAM.
Guard Interval	1/4, 1/8, 1/16, 1/32.
Code Rate	1/2, 2/3, 3/4, 5/6, 7/8.
FFT Mode (Carriers)	2K, 8K.
Bandwidth	6 MHz, 7 MHz and 8 MHz.

RF OUTPUT

Type	1 multiplex DVB-T with a digital television service.
Frequencies	50 – 865 MHz (C02-C69), adjustable to 10 kHz steps.
MER	> 38 dB at the whole range of frequencies.
Output Level	80 dBμV.
Top attenuation	Up to 40 dB.
Attenuation Step	1 dB.



CONNECTIONS

Video

RCA female 75 Ω (yellow)

Audio

RCA female (white the left channel, red the right channel).

RF

1 DVB-T output, type F female, 75 Ω .

1 RF input, type F female, 75 Ω . For loophrough or to connect several devices in sequence mode.

Power supply

External power supply 220-240 V AC.

CONFIGURATION

Through the built-in cursor keys and display.

POWER SUPPLY

Through the external power supply (included).

Voltage and highest consumption

12 V / 6 W.

ENVIRONMENTAL CONDITIONS

This equipment can be used on the following environmental conditions. The above mentioned specifications will apply in these conditions only:

Altitude

Up to 2000 m.

Temperature range

From 5 $^{\circ}\text{C}$ to 40 $^{\circ}\text{C}$.

Max. relative humidity

80 % (up to 31 $^{\circ}\text{C}$),
decreasing lineally up to 50% at 40 $^{\circ}\text{C}$.

MECHANICAL FEATURES

Dimensions

W. 130 x H. 145 x D. 40 mm.

Weight

271 g.

INCLUDED ACCESSORIES

AL-0122

Network adapter 100 - 240 V AC.

0 DG0085

Quick configuration guide.

RECOMMENDATIONS ABOUT THE PACKING

It is recommended to keep all the packing material in order to return the equipment, if necessary, to the Technical Service.





2 SAFETY RULES

















2.1 General

- * **The safety could not be assured if the instructions for use are not closely followed.**
- * Use this equipment connected only to devices or systems with their common at ground potential or insulated from the mains.
- * The external **DC** charger is a **Class I** equipment, for safety reasons plug it to a supply line with the corresponding ground terminal and only indoors.
- * When using some of the following accessories use only the specified ones to ensure safety:
 - Power adapter.
 - Power cord.
- * Remember that voltages higher than **70 V DC** or **33 V AC rms** are dangerous.
- * Use this instrument under the **specified environmental conditions**.
- * The user is not allowed to perform changes inside the equipment. Any change on the equipment must be done exclusively by specialized staff.
- * Do not obstruct the ventilation system of the equipment.
- * Use appropriate low-level radiation cables for input / output signals, especially on high level signals.
- * Follow the **cleaning instructions** described in the Maintenance paragraph.



* Symbols related with safety:

	DIRECT CURRENT		ON (Supply)
	ALTERNATING CURRENT		OFF (Supply)
	DIRECT AND ALTERNATING		DOUBLE INSULATION (Class II protection)
	GROUND TERMINAL		CAUTION (Risk of electric shock)
	PROTECTIVE CONDUCTOR		CAUTION REFER TO MANUAL
	FRAME TERMINAL		FUSE
	EQUIPOTENTIALITY		EQUIPMENT OR COMPONENT TO BE RECYCLED

2.2 Maintenance

2.2.1 Cleaning Recommendations

CAUTION

To clean the cover, make sure the instrument is disconnected.

CAUTION

Do not use scented hydrocarbons or chlorized solvents. Such products may damage the plastics used in the construction of the cover.

The cover should be cleaned by means of a light solution of detergent and water applied with a soft cloth.

Dry thoroughly before using the system again.

CAUTION

Do not use alcohol or its derivatives for the cleaning of the front panel and particularly the viewfinders. These products can damage the mechanical properties of the materials and reduce their useful lifetime.



3 INSTALLATION

3.1 Power Supply

To start using the **EN-106**, connect the external power supply to the 230V mains and the 12V to the instrument input.

Once connected to power, the device turns on and it takes about 20 seconds to be operational. Then the message **KEYBOARD LOCKED** appears on the display.

3.1.1 Operation via external power supply

Use only the external power adapter supplied with the instrument.

3.2 Connection

3.2.1 Connection diagram examples

- CONNECTION DIAGRAM FOR ONE MODULE

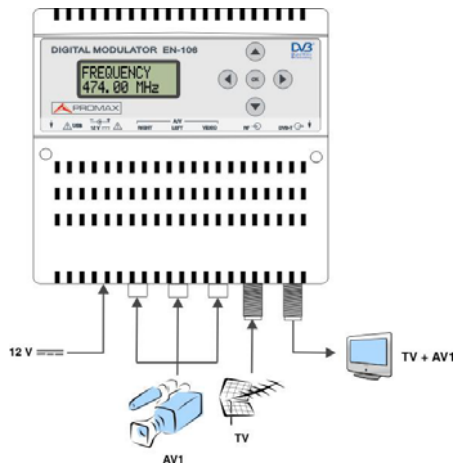

ATTENTION!
 FOR THIS CONFIGURATION YOU SHOULD USE OUTPUT FREQUENCIES DIFFERENT FROM THE ONES THAT YOUR TV IS CURRENTLY USING.



- **CONNECTION DIAGRAM FOR MULTIPLE MODULES**

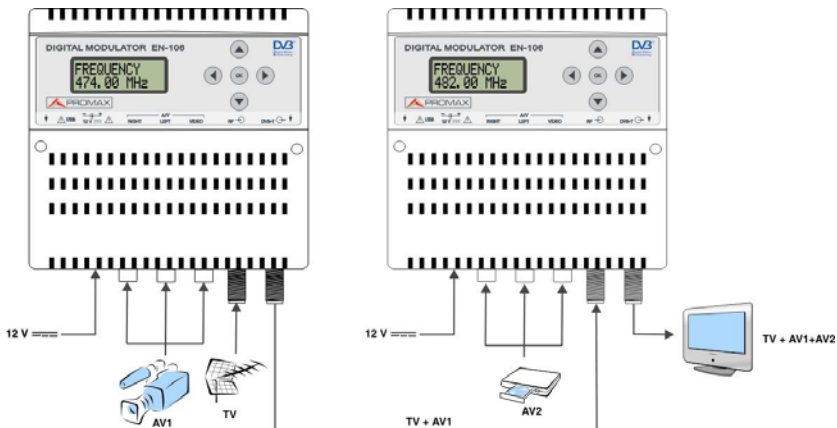

ATTENTION!
FOR THIS CONFIGURATION YOU SHOULD USE FOR EACH CHANNEL DIFFERENT OUTPUT FREQUENCIES AND TS ID VALUES.

3.3 Navigation and edition of values.

The instrument **EN-106** is configured through its 5 keys and front panel display. In general, it is not necessary to configure the instrument to generate a **DVB-T** signal compatible with any digital terrestrial television receiver.



Select parameter / menu.



Move Right / Left between menu / characters.



Increase / Decrease value of the figure / field.



4 OPERATING INSTRUCTIONS

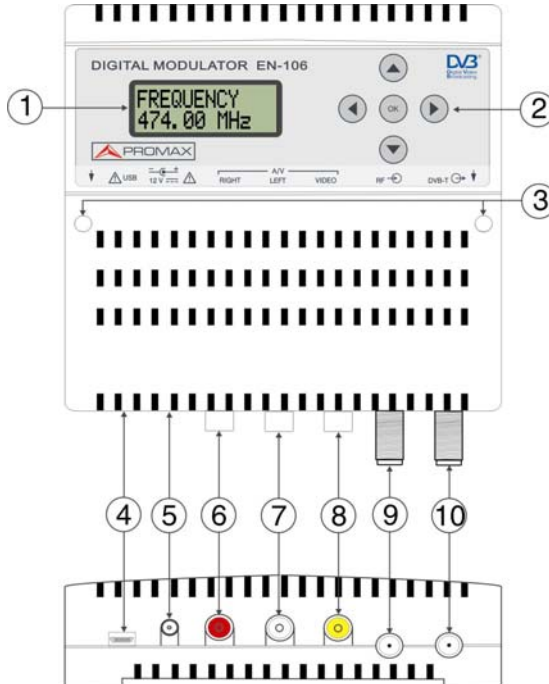

4.1 Description of controls and components



- 1.- Display (LCD).
- 2.- Menu navigation keys.
- 3.- Through holes for fixing screws on the wall.
- 4.- USB mini-B Female Connector.
- 5.- Input 12 V DC power adapter (included).
- 6.- Right audio input.
- 7.- Left audio input.
- 8.- Video input.
- 9.- TV RF input.
- 10.- TV COFDM Output.



4.2 Starting

- 1.- After connecting the power to the instrument, the message **"PLEASE WAIT.."** appears for 20 seconds.
- 2.- Then the message **"KEYBOARD LOCKED"** appears. To access to the configuration menus the user has to enter a password.
- 3.- Press **OK** .
- 4.- The field **"PASSWORD"** appears. Enter the access code. (By default: 0000).
- 5.- Press **OK** .
- 6.- The field **"FREQUENCY"** appears, this is the first option on the configuration menu.

4.3 BASIC configuration menu

On the first level there are the basic options for the instrument configuration:

FREQUENCY: It sets the frequency value for the output signal. The frequency range is from 50 MHz to 865 MHz. (By default: 474 MHz).

Important: Check that the selected frequency is not already being used by a current television distribution channel.

ATTENUATOR: It adjusts the power level of the output signal, in dB units. Attenuation range from 0 to 40 dB. (By default: 20 dB).

SAVE CHANGES: It saves the current configuration on the non-volatile memory of the instrument.

ADVANCED MENU: Through this menu you access the advanced configuration options. These options are detailed in the following section.



4.4 ADVANCED configuration menu

When accessing through the option "**Advanced Options**", which is at the basic configuration level, you access the advanced configuration level where there are the options to configure the instrument.

- SERVICE:** Television service name. (By default: "**PROMAX**").
- SERVICE ID:** It allows you to edit the service identifier that is being digitised.
- TYPE:** It allows the user to select the type of service to digitise. Options are TELEVISION (video and audio service encoded) or RADIO (only audio service encoded with no video).
- LCN:** It specifies the index for the service sorting on the digital terrestrial television receiver. Values are between 1 and 999.
- PRIV. DATA SP:** Private data Specifier. The receiver uses it to properly identify the LCN value. (Default value according to the user's country; consult the table with pre-set values).
- ORIG. NET ID:** Identifier of the original network. It is the number to identify the network from where the signal comes. (Default value according to the user's country; consult the table with pre-set values).
- NETWORK ID:** It is the number that identifies the network where the signal is distributed. (Default value according to the user's country; consult the table with pre-set values).
- TS ID:** It is the transport stream identifier. (Default value according to the user's country; consult the table with pre-set values).
- Important:** **TS ID** and **SERVICE ID** can not match up with those that already exist on the current television distribution network.
- NIT VERSION:** Network Information Table version. In some countries it should match with other tables version received from the receiver. (Default value according to the user's country; consult the table with pre-set values).



AUDIO GAIN: Audio gain at the input. Available values are from -12 dB to +30 dB (By default: 0 dB).

AUDIO MODE: Type of audio to encode. Available options are Stereo, Mono, Dual and Joint Stereo (By default: Stereo).

AUDIO

BITRATE: Bitrate to encode the audio. Available values are between 96 kbit/s and 384 kbit/s (By default: 256 kbit/s).

Note: For bitrates of 224 Kbit/s or greater, the audio mode can not be mono.

VIDEO STD: Standard of the video input (PAL, NTSC or SECAM). (By default: PAL).

ASPECT RATIO: Aspect ratio applied when encoding the video (4:3, 16:9). (By default 16:9).

CHANNEL BW: Channel bandwidth (6, 7 or 8 MHz). (Default value according to the user's country; consult the table with pre-set values).

CARRIERS: Signal transmission mode, 2K or 8K. (Default value according to the user's country; consult the table with pre-set values).

GUARD INTER.: Safety signal margin (1/4, 1/8, 1/16, 1/32). (Default value according to the user's country; consult the table with pre-set values).

CONSTELLA.: Constellation type used to transmit signal (QPSK, 16QAM, 64QAM). (Default value according to the user's country; consult the table with pre-set values).

CODE RATE: Available values are (1/2, 2/3, 3/4, 5/6, 7/8). (Default value according to the user's country; consult the table with pre-set values).

LANGUAGE: Language used on the menus. It can be Spanish, English, French or Italian.

VERSION: It shows the firmware version installed in the instrument. This option is not editable.



NEW

PASSWORD: It allows the user to change to a new password to access the menu.

RESET

SETTINGS: It returns to the default values.

BASIC OPTIONS: It returns to the first menu with the basic configuration options.



4.5 Menu tree

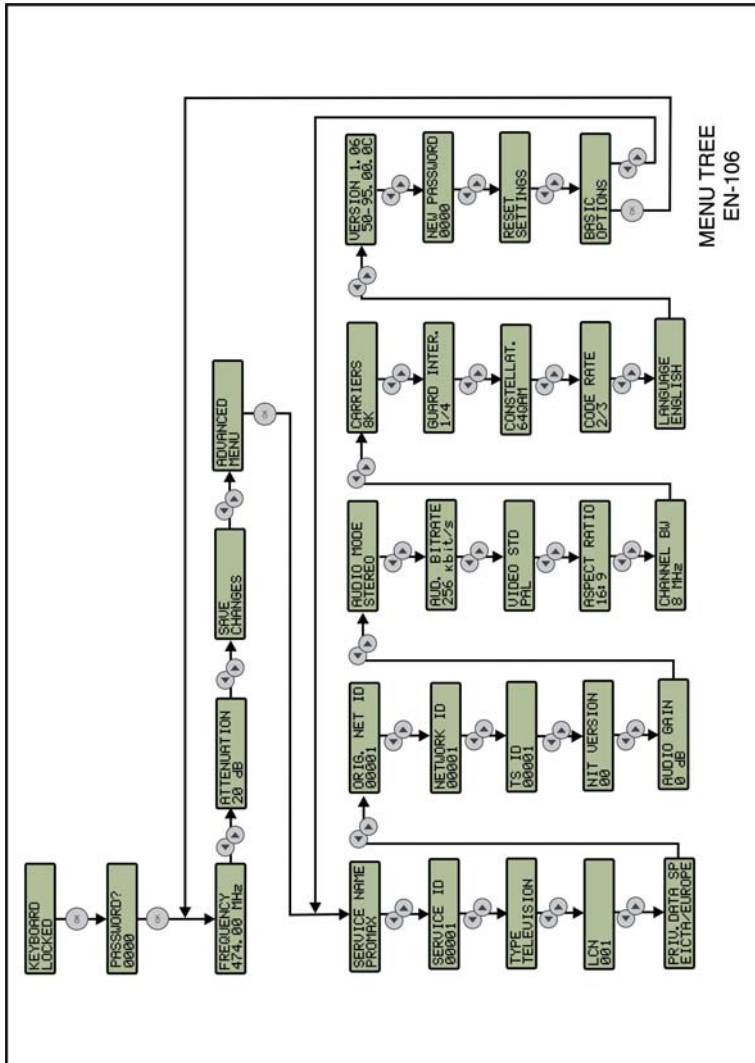



4.6 Parameter only accessible from the Configuration Utility

The following parameters are accessible only from the configuration utility **EN-106** (see next chapter "**Configuration Utility**"). The remaining parameters can be modified both the configuration utility and from the module.

VIDEO PID: ID of the video packets. Valid values are between 32 and 8190, and must be different from AUDIO PMT PID and PID.

AUDIO PID: ID of the audio packets. Valid values are between 32 and 8190, and must be different from PMT PID and PID VIDEO.

PID PCR: PCR packet identifier. Valid values are between 32 and 8190, and must be different from PMT PID.

PMT PID: ID of the PMT packets. Valid values are between 32 and 8190, and should be different from the other PID values.

PROGRAM

DESCRIPTION: Description of the program, which will appear in the Electronic Program Guide DTT receiver.

RED NAME: Name of TV distribution network.

PROVIDER

NAME: Name of program provider.



5 CONFIGURATION UTILITY

The **EN-106 Configuration Utility** is an easy to use program for Windows, that allows the user to configure parameters of the **EN-106** modulator from a personal computer, instead to do it from the modulator display itself. Few of these parameters are only accessible from the Configuration Utility. It also allows updating the modulator software.

Processes to install and use the **EN-106** are detailed below.

5.1 Installing the EN-106 Configuration Utility.

- 1.- Download the latest version of the Software **EN-106** from the **PROMAX** website.
- 2.- Unzip the downloaded file, then the "**EN106_vX.X_setup.exe**" file appears.
- 3.- Double click on the file to run the setup application and follow the steps.

5.2 EN-106 Configuration Utility

- 1.- Connect the USB cable between the device micro-USB port (powered) and the computer USB port.
- 2.- Run the program by double-clicking on the desktop icon "EN-106 Configuration Utility".
- 3.- Once the program is working, a window appears with three tabs. Each tab provides access to a particular function. At the bottom there is a white box showing all the orders and processes that the instrument is doing.
- 4.- When the program starts, it tries to communicate with the device. If successful, it identifies the device and downloads its configuration, showing it on screen. If there is no communication, it will show the reason in the white box on screen.
- 5.- If needed to stop / resume communication between the device and the program, click on the Disconnect / Connect button respectively.



The following list shows each tab and its function:

Configuration: It allows you to modify, load, save, send and receive parameters to / from the device. Parameters can be changed individually or depending on the region / country.

Update: It allows updating the device software.

Help: It explains the meaning of every parameter and it allows changing the language.

Each one of these functions is explained below.

5.2.1 Configuration

The configuration window is as follows:

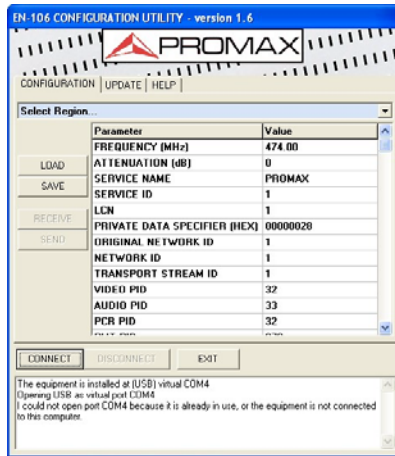

It is divided into the following parts:

Dropdown menu: From this menu you can select the country or region whose standard parameters you want to send to the device or modify.



Table of parameters and values:

This table lists all parameters and values associated with the selected region or the values received from the device. Some of these parameters are accessible only through the Utility Configuration. Click on the text box to change the parameter value. Depending on the type of parameter the user should directly write a new value or select the value from a dropdown menu.

Load option: It opens a window to select and load an XML file extension, which contains the parameters values for the modulator.

Save option: It opens a window to save an XML file extension with the values of the current modulator parameters.

Receive option: It receives the parameters values from the modulator and shows them on screen.

Send option: It sends the parameters values on screen to the modulator.

5.2.2 Updating

The update window is as follows:

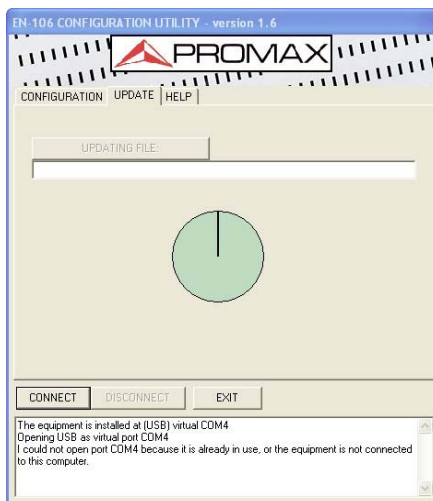



- 1.- To update you must click on the button "Updating File".
- 2.- It opens a window to select and load the update file ("**PRO**" extension). This file must be previously downloaded to the computer. The update file can be downloaded from the **PROMAX** website.
- 3.- Once the file is selected, the program will ask the user if he wants to update the device software. If the answer is yes, it starts the updating process.
- 4.- As you passed the updating process, the circle will be completed. The process ends when the circle is completely filled.
- 5.- When the update finish a confirmation message appears and the modulator must be restarted to recognize the new software.

5.2.3 Help

The Help window is as follows:

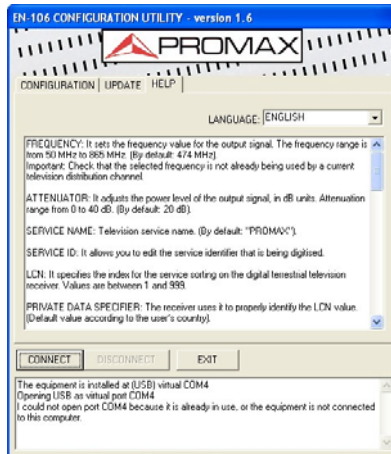

The help window has a window with a brief description of all the editable parameters of the modulator.

It also has a dropdown menu where the user can select the language to use in the program. The available languages are Spanish, English and French.



ANNEX 1 REFERENCE TABLE FREQUENCY – CHANNEL FOR UHF

EUROPE

BANDWIDTH: 8 MHz.

Channel	Digital carrier (MHz)	Channel	Digital carrier (MHz)	Channel	Digital carrier (MHz)
21	474.00	38	610.00	55	746.00
22	482.00	39	618.00	56	754.00
23	490.00	40	626.00	57	762.00
24	498.00	41	634.00	58	770.00
25	506.00	42	642.00	59	778.00
26	514.00	43	650.00	60	786.00
27	522.00	44	658.00	61	794.00
28	530.00	45	666.00	62	802.00
29	538.00	46	674.00	63	810.00
30	546.00	47	682.00	64	818.00
31	554.00	48	690.00	65	826.00
32	562.00	49	698.00	66	834.00
33	570.00	50	706.00	67	842.00
34	578.00	51	714.00	68	850.00
35	586.00	52	722.00	69	858.00
36	594.00	53	730.00		
37	602.00	54	738.00		

AUSTRALIA

BANDWIDTH: 7 MHz.

Channel	Digital carrier (MHz)	Channel	Digital carrier (MHz)	Channel	Digital carrier (MHz)
28	530.00	43	635.00	58	740.00
29	537.00	44	642.00	59	747.00
30	544.00	45	649.00	60	754.00
31	551.00	46	656.00	61	761.00
32	558.00	47	663.00	62	768.00
33	565.00	48	670.00	63	775.00
34	572.00	49	677.00	64	782.00
35	579.00	50	684.00	65	789.00
36	586.00	51	691.00	66	796.00
37	593.00	52	698.00	67	803.00
38	600.00	53	705.00	68	810.00
39	607.00	54	712.00	69	817.00
40	614.00	55	719.00		
41	621.00	56	726.00		
42	628.00	57	733.00		





ANNEX 2 RECOMENDED VALUES TABLE

	SPAIN	FRANCE	FINLAND
NETWORK ID	12600	8442	13099
ORIG. NET ID	8916	8442	8438
TS ID	1	10	1
PRIV. DATA SP	0x00000028	0x00000028	0x00000029
NIT VERSION	0	27	1
VIDEO STD	PAL	PAL	PAL
CARRIERS	8K	8K	8K
CONSTELLATION	64QAM	64QAM	64QAM
CHANNEL BW	8 MHz	8 MHz	8 MHz
CODE RATE	2/3	2/3	2/3
GUARD INTER.	1/4	1/32	1/8

	UK	ITALY	CZECH REP.	AUSTRALIA
NETWORK ID	12293	12289	12810	12818
ORIG. NET ID	9018	8572	8395	0
TS ID	1	33	1	1
PRIV. DATA SP	0x0000233A	0x00000028	0x00000028	0x00003200
NIT VERSION	0	0	0	0
VIDEO STD	PAL	PAL	PAL	PAL
CARRIERS	8K	8K	8K	8K
CONSTELLATION	64QAM	64QAM	64QAM	64QAM
CHANNEL BW	8 MHz	8 MHz	8 MHz	7 MHz
CODE RATE	5/6	5/6	2/3	3/4
GUARD INTER.	1/32	1/32	1/32	1/16





ANNEX 3 TROUBLESHOOTING

Problem:	After scanning the whole TV band, I cannot find the digital service.
Possible solution:	<ul style="list-style-type: none"> - Check the frequency you are using is not already in use in a channel of the distribution network. - Check that NID and ONID parameters correspond to your country. Check the recommended table values. - Check the TS-ID is not the same as the one already being used in the TV distribution network or as the one used in any other EN-106 module. - Check attenuation and put it to 0 dB.

Problem:	After scanning the whole TV band, it finds the service but it is not saved on the desired position.
Possible solution:	<ul style="list-style-type: none"> - Check the LCN is correct. - Review NID, ONID and Private_Data_Specifier values. Check the recommended table values.

Problem:	TV shows on screen a message similar to this one: "Network parameters have changed. Do you want to scan again?"
Possible solution:	<ul style="list-style-type: none"> - Check the NIT version and use the one recommended in the table for all modules.

Problem:	TV audio saturates.
Possible solution:	<ul style="list-style-type: none"> - Reduce the audio gain.



Problem:	I have forgotten the password.
solution:	- Contact PROMAX (+34 93 184 77 02).

Problem:	Strange colours on screen.
Possible solution:	- Check the TV standard is correct (PAL / NTSC / SECAM).

Problem:	Image on screen is pixelated or has bad quality.
Possible solution:	- Check COFDM parameters. Check the table with recommended values. - Reset settings.



**DESTINATION LABEL
TECHNICAL SUPPORT SERVICE.**



A (receptor/receiver)

PROMAX ELECTRONICA S. L.

C/ Francesc Moragas, 71-75

08907 L'HOSPITALET DE LLOBREGAT (Barcelona)

SPAIN

Tel. : 93 184 77 02

